



Ecophon Solo™ Rectangle Akutex HS

Solo Rectangle Akutex HS is a water resistant free hanging unit, offering a high degree of design possibility. Solo Rectangle Akutex HS is primarily suited for swimming pool areas with high humidity and occasional direct water.



SYSTEM RANGE

	Size, mm	1800x1200	2400x1200
	Special Fixing	•	•
	Thickness (THK)	40	40
	Inst. Diagr.	M436C4	M441C4

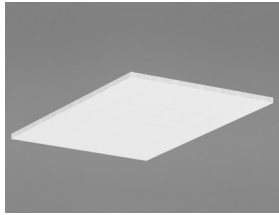

Solo Rectangle Akutex HS

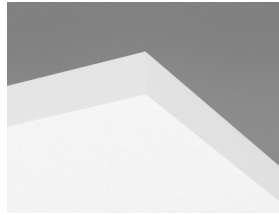

Solo Rectangle Akutex HS tile

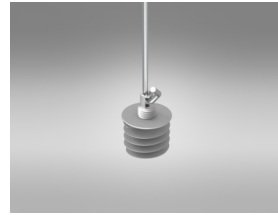

Suspension with Adjustable Hanger C4 and Absorber Anchor

Acoustic



The values in the diagram refer to a single unit. If the units are arranged in a cluster with distances between units less than 0,5 meters, the Aeq per unit will be slightly reduced.

Sound Absorption:

Test results according to EN ISO 354.

A_{eq} Equivalent absorption area per unit (m² sabin)

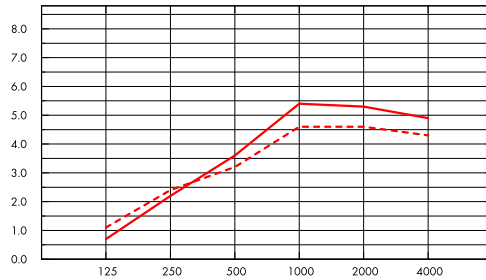

- Solo Rectangle 2400x1200/Akutex HS, 400 mm o.d.s.
- Solo Rectangle 2400x1200/Akutex HS, 1000 mm o.d.s.

o.d.s = overall depth of system

Frequency Hz

A_{eq} Equivalent absorption area per unit (m² sabin)

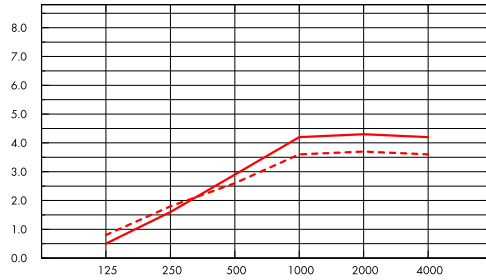

- Solo Rectangle 1800x1200/Akutex HS, 400 mm o.d.s.
- Solo Rectangle 1800x1200/Akutex HS, 1000 mm o.d.s.

o.d.s = overall depth of system

Frequency Hz

	THK mm	o.d.s. mm	A _{eq} Equivalent absorption area per unit (m ² sabin)					
			125 Hz	250 Hz	500 Hz	1000 Hz	2000 Hz	4000 Hz
2400x1200	40	400	1.1	2.4	3.2	4.6	4.6	4.3
2400x1200	40	1000	0.7	2.2	3.6	5.4	5.3	4.9
1800x1200	40	400	0.8	1.8	2.6	3.6	3.7	3.6
1800x1200	40	1000	0.5	1.6	2.9	4.2	4.3	4.2

Indoor Air Quality



Certificate / Label

Eurofins Indoor Air Comfort®

IAC

French VOC

A

Finnish M1

•



Environmental Footprint



kg CO₂ equiv/m²

Solo Rectangle

9,64

Life-cycle stages A1 to C4 from EPD, in conformity with ISO 14025 / EN 15804



Circularity

Minimum post-consumer recycled content	54%
Recyclability	Fully recyclable



Fire safety

Country	Class	
Europe	EN 13501-1	A2-s1,d0

The glass wool core of the tiles is tested and classified as non-combustible according to EN ISO 1182.



Humidity Resistance

Class C, relative humidity 95% and 30°C, according to EN 13964:2014



Visual appearance

White 500, nearest NCS colour sample S 0500-N, 84% light reflectance.



Cleanability

Daily dusting and vacuum cleaning. Weekly wet wiping.



Accessibility

The tiles are demountable.



Installation

Installed according to installation diagrams, installation guides and drawing aid. For information regarding minimum overall depth of system see quantity specification.



System weight

Approximately 6,5-17,5 kg.



Mechanical properties

No additional live load is allowed.



CE

Ecophon ceiling systems are CE marked according to the European harmonized standard EN 13964:2014. CE marked construction products are covered by a Declaration of Performance (DOP) which enables customers and users to easily compare performance of products available on the European market.

INSTALLATION DIAGRAM (M436C4) FOR ECOPHON SOLO™ RECTANGLE AKUTEX HS C4 1800X1200

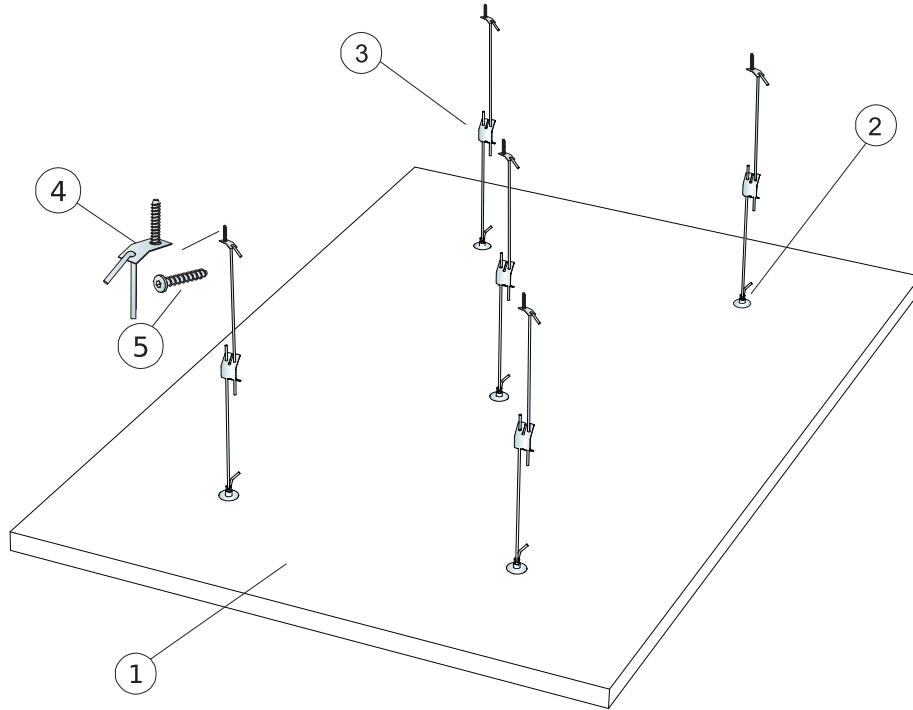

QUANTITY SPECIFICATION (EXCL. WASTAGE)

		Size, mm
		1800x1200
1	Solo Rectangle Akutex HS	2,16m ² /panel
2	Connect Absorber Anchor	5/panel
3	Connect Adjustable Hanger C4	5/panel
4	Connect Fixing Plate C4	5/panel
5	Connect Anchor Screw C4	5/panel
Δ Min. overall depth of system: Δ 410 mm		-

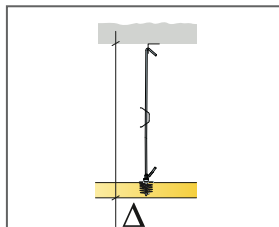

See Quantity Specification

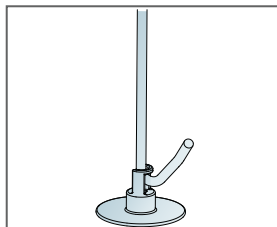

Connect Adjustable Hanger C4 mounted in Connect Absorber Anchor

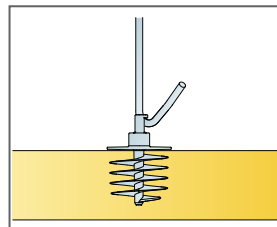

Connect Absorber Anchor mounted in panel

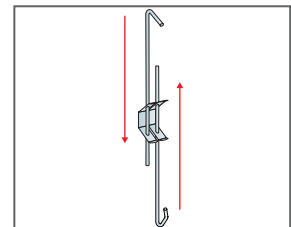

Adjustable suspension with Connect Adjustable Hanger C4

INSTALLATION DIAGRAM (M441C4) FOR ECOPHON SOLO™ RECTANGLE AKUTEX HS 2400X1200

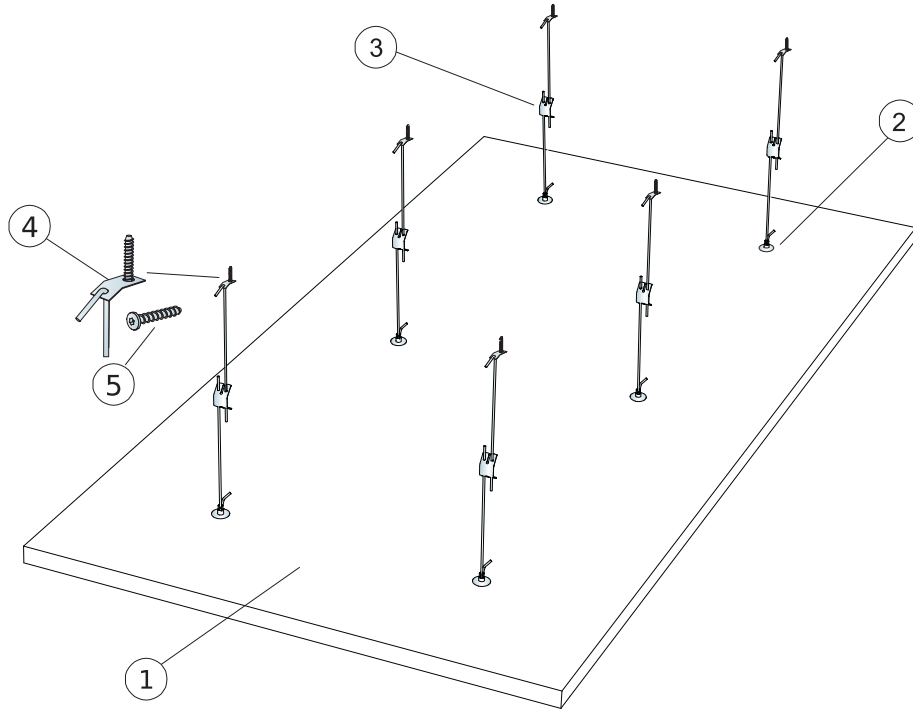

QUANTITY SPECIFICATION (EXCL. WASTAGE)

		Size, mm
		2400x1200
1	Solo Rectangle Akutex HS	2,88m ² /panel
2	Connect Absorber Anchor	6/panel
3	Connect Adjustable Hanger C4	6/panel
4	Connect Fixing Plate C4	6/panel
5	Connect Anchor Screw C4	6/panel
Δ Min. overall depth of system: Δ 410 mm		-

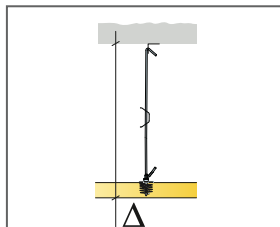

See Quantity Specification

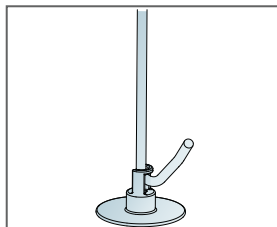

Connect Adjustable Hanger C4 mounted in Connect Absorber Anchor

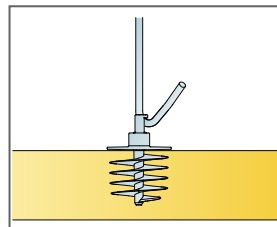

Connect Absorber Anchor mounted in panel

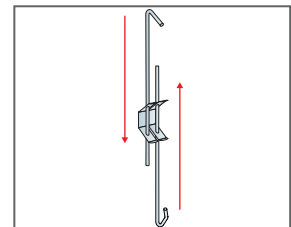

Adjustable suspension with Connect Adjustable Hanger C4