

# Ecophon Focus™ Fixiform E

Ecophon Focus™ Fixiform E creates distinct transitions between different levels of ceiling to accommodate various ceiling service installations or to add shape and structure to the room. Tiles are delivered flat and folded to 90 degrees on site before installation.

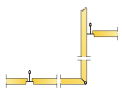

## SYSTEM RANGE



Size, mm	1200x600
T24	•
Thickness (THK)	20
Inst. Diagr.	M276



Focus Fixiform panel

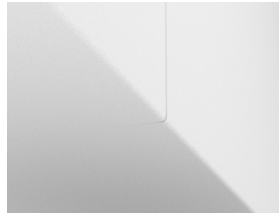

Detail of Focus Fixiform system fold



Focus Fixiform E system



Focus Fixiform E system upper level

## Acoustic



Acoustic values corresponding to a flat ceiling.

### Sound Absorption:

Test results according to EN ISO 354. Classification according to EN ISO 11654, and the single value ratings for Noise Reduction Coefficient, NRC and Sound Absorption Average, SAA according to ASTM C 423.

$\alpha_p$ , Practical sound absorption coefficient

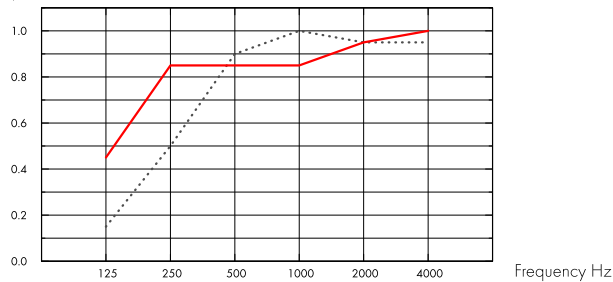

..... Focus Fixiform E 20 mm, 60 mm o.d.s.  
 — Focus Fixiform E 20 mm, 200 mm o.d.s.  
 o.d.s = overall depth of system

THK mm	o.d.s. mm	$\alpha_p$ , Practical sound absorption coefficient						$\alpha_w$	Sound absorption class
		125 Hz	250 Hz	500 Hz	1000 Hz	2000 Hz	4000 Hz		
20	60	0.15	0.50	0.90	1.00	0.95	0.95	0.80	B
20	200	0.45	0.85	0.85	0.85	0.95	1.00	0.90	A

THK mm	$D_{nfw}$		CAC dB	
	Weighted normalized flanking level difference, ISO 10848-2		Ceiling Attenuation Class, ASTM 1414, ASTM E413	
20	24		25	

## Indoor Air Quality



Certificate / Label	
Eurofins Indoor Air Comfort®	IAC
French VOC	A
Finnish M1	•



## Circularity



Minimum post-consumer recycled content	57%
Recyclability	Fully recyclable

## Fire safety



Country	Class	
Europe	EN 13501-1	A2-s1,d0

The glass wool core of the tiles is tested and classified as non-combustible according to EN ISO 1182.



### Humidity Resistance

---

Class C, relative humidity 95% and 30°C, according to EN 13964:2014



### Visual appearance

---

White Frost, nearest NCS colour sample S 0500-N, 85% light reflectance. Gloss < 1.



### Cleanability

---

Daily dusting and vacuum cleaning. Weekly wet wiping.



### Accessibility

---

The panels are demountable via adjacent flat ceiling tiles.



### Installation

---

Installed according to installation diagrams, installation guides and drawing aid. Focus Fixiform E is supplied with all necessary installation accessories.



### Mechanical properties

---

Additional live load has to be fixed to the soffit.



### CE

---

Ecophon ceiling systems are CE marked according to the European harmonized standard EN 13964:2014. CE marked construction products are covered by a Declaration of Performance (DOP) which enables customers and users to easily compare performance of products available on the European market.

INSTALLATION DIAGRAM (M276) FOR ECOPHON FOCUS FIXIFORM E

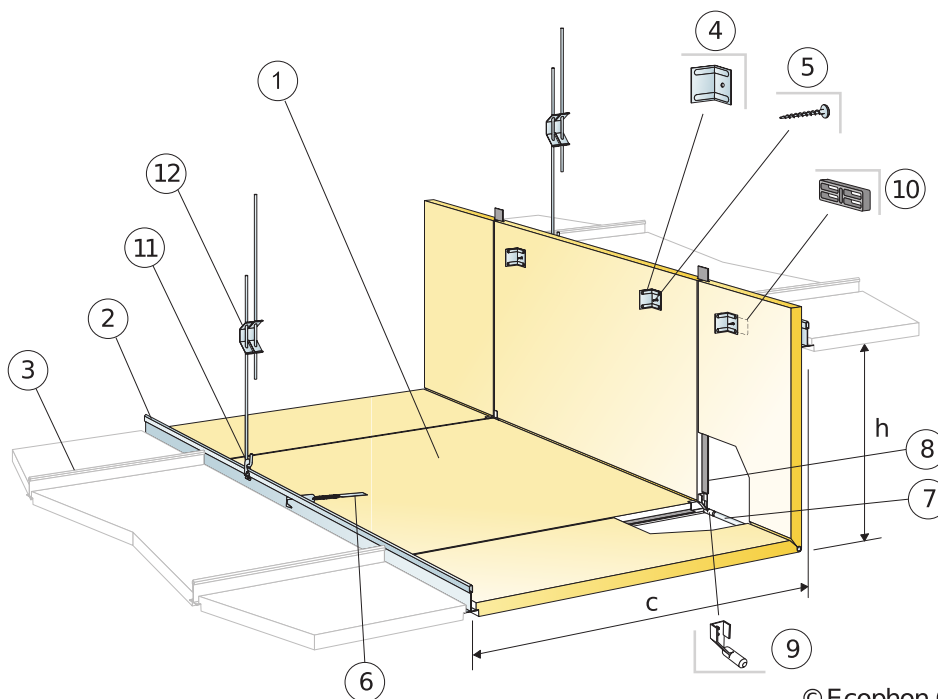

© Ecophon Group

QUANTITY SPECIFICATION (EXCL. WASTAGE)

		Size, mm
		1200x600
1	Focus Fixiform E (kit)	as required
2	Connect T24 Main runner	1,8m/m <sup>2</sup>
3	Connect T24 Cross tee (adjacent ceiling)	as required
4	Angle Bracket Fixiform (included in Fixiform kit)	-
5	Absorber screw metal 50 (included in Fixiform kit)	-
6	Connect Hook (included in Fixiform kit)	-
7	Reinforcement rod (included in Fixiform kit)	-
8	Connect F Spline (included in Fixiform kit)	-
9	Plug for reinforcement rod (included in Fixiform kit)	-
10	Distance (included in Fixiform kit)	-
11	Connect Hanger clip	1 pcs/hanger
12	Connect Adjustable hanger, installed at 600 mm centres at the level change	1,4/m <sup>2</sup>
Δ Min. overall depth of system: Δ1=160 mm and Δ2=80 mm from upper level		-
δ Min. demounting depth: Individual ceiling tiles are non-demountable		-
Dimension: c=600 mm, h<530 mm		-

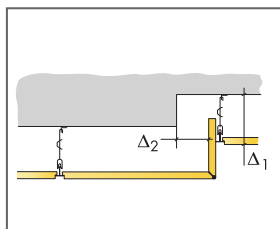

See Quantity specification

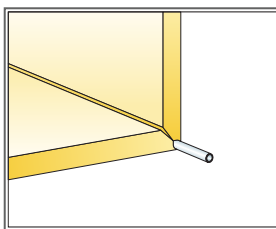

The fold is reinforced by a rod

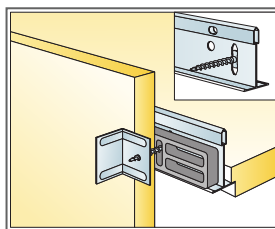

Upper level connection to Main runner

Size, mm	Max live load (N)	Min load bearing capacity (N)
1200x600x20	0	160

Live load/load bearing capacity