

Department for Building Physics
Fire Laboratory and Fire Engineering

Zaved za gradbeništvo Slovenije

Slovenian National Building and Civil Engineering Institute

Dimitrova ulica 12, 1000 Ljubljana, Slovenija

http://www.zag.si, e-mail: info@zag.si

Ljubljana, December 4th, 2013



Požarni laboratorij, Sr. Gameljne 41, Ljubljana-Šmartno

TEST REPORT

No. P 0578/13-530-1

FIRE RESISTANCE TEST of
non-loadbearing gypsum acoustic plasterboard
partition

INDEX acoustic wall

Applicant: INDEX S.p.A, Via G. Rossini 22, Castel d'Azzano (Verona), ITALY
Order No.: 13-011-000578 dated 29th of May 2013

Responsible Investigator:
Aleksander Bergant, B.Sc.



Head of Fire Laboratory:
Milan Hajduković, B.Sc.

Director:
Assoc. Prof. Dr. Andraž Legat

Approved laboratory according to SIST EN ISO/IEC 17025 (Chart of accreditation No. LP-005, SA), Notified body No. 1404

Other accreditations: BUREAU VERITAS (Certificate of Recognition No. SMS.LAB.462/2900/C.0)
Member of EPLF - European Group of Organisations for Fire Testing, Inspection and Certification

The test results relate only to the tested sample. Test report may be reproduced only as a whole. Complaints regarding the content of this report will only be considered if received within 15 days of the date of issue of the report. Number of pages: 32, Number of enclosures: 7

Obr. P.S. 12-001-01/2

1. **PRODUCT:** Non-loadbearing gypsum acoustic plasterboard partition **INDEX acoustic wall**
2. **SUPPLIER:** INDEX S.p.A, Via G. Rossini 22, Castel d'Azzano (Verona), ITALY
3. **MANUFACTURER:** INDEX S.p.A, Via G. Rossini 22, Castel d'Azzano (Verona), ITALY
4. **SAMPLING:** The wall material was sampled and delivered by the sponsor to the fire laboratory on 16th of July 2013. ZAG sample No. P13/069.

5. DESCRIPTION OF THE TEST SPECIMEN

All dimensions are in millimetres.

The test specimen was erected on 16th of June 2013 in a test frame of dimension 3015 × 3015.

The construction of the wall specimen of dimension 2963 × 3015 × 186 was made on two metal frameworks, each constructed of two horizontal and six vertical 50 mm deep metal profiles. Top, bottom and one edge vertical profile were fixed to the testing frame. One edge stud profile was not fixed to the side edge of testing frame. Distances between stud profiles were 600 mm, except the distance to the free-edged stud profile was 540 mm. The gap between the free-edged stud profile and the side edge of the testing frame was 52 mm wide. The distance between two frameworks was 30 mm.

Two layers of 12.5 mm thick gypsum boards KNAUF GKB (A) were fixed to the outer side of each metal framework by means TN screws $\phi 3.5 \times 25$ and $\phi 3.5 \times 35$ at a distance of approximately 600 mm between screws respectively. On the inner face of both inner gypsum board layers a 3 mm thick INDEX Topsilent Bitex sound barrier (nominal density 4 kg/m², measured density 5 kg/m²) was placed and fixed by means of water-based glue INDEX Fonocoll.

All joints between gypsum boards were sealed with gypsum filler and covered with glass fibre tape.

The wall specimen was insulated with two layers of 50 mm thick rock wool KNAUF INSULATION DP-5 (nominal density 50 kg/m³, measured density 57,2 kg/m³) placed into each framework. Gaps between the fixed framework profiles and test frame were sealed by means of INDEX Fonocell PE-strip.

The free edge between the wall specimen and the test frame was filled with rock wool.

Drawings of the specimen wall made by the supplier are in enclosure No. 6.

5.1. Number of specimens

Fire resistance test was performed on one specimen.

5.2. Applied loading

The specimen was not loaded during the test.

6. CONDITIONING OF THE SPECIMEN

Before the test the specimen was for six days in the Fire laboratory where the temperature was around 20°C and relative humidity around 60 %.

The test results relate only to the tested sample. Test report may be reproduced only as a whole.

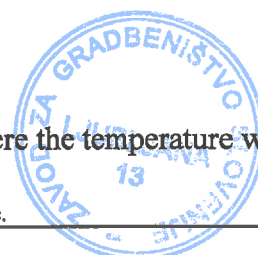

7. DATE OF THE TEST 22nd of July 2013

8. TESTING PROCEDURE

The test was carried out according to SIST EN 1363-1:2012 (identical to EN 1363-1:2012) and SIST EN 1364-1:1999 (identical to EN 1364-1:1999).

Representatives of the customer were presented at the test.

8.1. Preliminary measurements

Verification of construction details:

During the specimen construction the construction details were verified and proved to be in concordance with enclosed documentation.

8.2. Test conditions:

- the furnace 3000 × 3000 and 1200 deep was oil fired;
- the ambient temperature at the commencement of the test: 24 °C
- air moisture content at the commencement of the test: 53 %

8.3. Temperature inside the furnace

The temperature inside the furnace was measured by means of six plate thermocouples NiCr-Ni. These thermocouples extended through the furnace wall into the burning space to approximately 100 mm from the exposed face of the test specimen. The furnace temperature was continuously controlled such that it follows the standard time-temperature curve within the accuracy specified in SIST EN 1363-1:2012:

$$T = 345 \log_{10}(8t + 1) + 20$$

T temperature inside the furnace in °C
t time in minutes

Diagram of the temperature inside the furnace is in the enclosure No. 2.

8.4. Overpressure inside the furnace

The overpressure inside the furnace was measured by means of one pressure transducers Ashcroft XLDP3, computer and appropriate software. It was controlled by means of damper inside the exhaust in such a way that the overpressure inside the furnace at 2500 mm of specimen height was approximately 17 Pa.

The diagram of the overpressure is in enclosure No. 3.

8.5. Temperature rise on the unexposed surface of the test specimen

The temperature rise on the unexposed face of the test specimen was measured by means of 18 thermocouples NiCr-Ni. The thermocouples for surface temperature measurement consist of a 0.2 mm thick by 12 mm diameter copper discs, to which 0.5 mm in diameter NiCr-Ni thermocouples are soldered. The thermocouples were covered with a 30 mm square by 2 mm thick insulating pads density approximately 900 kg/m³ regarding to standard SIST EN 1363-1:2012. The thermocouples were kept in position by means of inorganic glue. Two thermocouples were placed inside the wall specimen.

Sketch of the unexposed face temperature rise measuring points is in enclosure No. 1.

Measuring point No. 1at the centre of the specimen

Measuring points No. 2 to 5at the centre of each quarter of the specimen

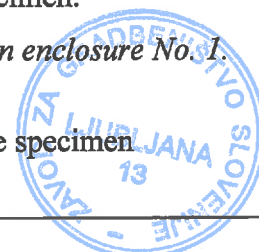

Measuring point No. 6, 8at vertical joint, 15 mm from the top edge
 Measuring point No. 7.....at mid-width, 15 mm from the top edge
 Measuring point No. 9 - 13in the upper half of the specimen, 15 mm from vertical or horizontal joints
 Measuring point No. 14at mid-height, 15 mm from restrained vertical edge
 Measuring point No. 15, 16at mid-height, 15 mm from vertical joint
 Measuring point No. 17at mid-height, 100 mm from free vertical edge

The diagrams of the unexposed face temperature rise measurement are in enclosure No. 4.

9. OBSERVATIONS DURING THE TEST

9.1 Visual observation

TIME [min]	SIDE *	OBSERVATION
0		The test commenced;
13	E	The first layer of gypsum boards was cracked;
21	E	Cracks in the first layer of gypsum boards were approximately 5-10 mm wide;
29	E	Some parts of first layer of gypsum boards fell off;
39	E	The second layer of gypsum boards was cracked, fire was issuing out of cracks;
46	E	Some parts of the second layer gypsum boards fell off, intense flaming was issuing out of wall;
65	E	In the middle part of the wall, the first layer of insulation fell off;
80	U	Some cracks were noticed on joints of the first layer of gypsum boards (right vertical joint near thermocouples on measuring points 11, 12 and 16) in the upper half of the wall;
89	U	The wall was bent into the furnace on the free edge side;
110	U	Thermocouple on measuring point 9 fell off, because it was attached on a screw. Measurement will not be taken into consideration.
116	U	Temperature measuring with roving thermocouple – on measuring point 9, 20mm away from the screw – temperature did not exceed 180 K – insulation sustained.
121	U	The test having been discontinued due to safety reason.

E - exposed side,
 U - unexposed side

DEFLECTION OF THE SPECIMEN:

Deflection of the specimen (measuring point II and IV) and joints (measuring point I and III).
 The positive values mean bending of the specimen into the furnace.

The test results relate only to the tested sample. Test report may be reproduced only as a whole.

Obr. P.S. 12-001-01/2

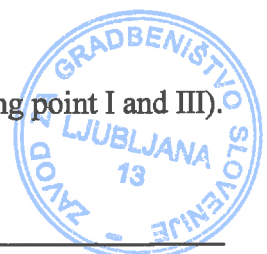

Opening of the joints (measuring point A and B).

Time [min]	Measuring point [mm]				
	I	II	III	IV	V
0	0	0	0	0	0
5	0	0	0	0	0
15	0	0	0	0	0
30	7	9	8	7	1
45	14	14	13	9	1
60	34	45	43	28	3
75	59	72	70	49	4
90	63	79	80	43	-10
100	65	81	81	38	-18
115	68	81	82	34	-23

9.2 INTEGRITY

Integrity of the test specimen was not lost.

9.3 INSULATION

The average temperature rise (140 K) on the unexposed face of the test specimen was not exceeded.

The maximum temperature rise (180 K) on the unexposed face of the test specimen was not exceeded.

Diagram of the temperature rise on the unexposed face of the test specimen is in enclosure No. 4.

10. TEST RESULTS:

INTEGRITY - E:

- sustained flaming 120 minutes no failure
- gap gauge 120 minutes no failure
- cotton pad 120 minutes no failure

INSULATION - I: 120 minutes no failure

This report details the method of construction, the test conditions and the results obtained when the specific element of construction described herein was tested following the procedure outlined in EN 1363-1, and where appropriate EN 1363-2. Any significant deviation with respect to size, constructional details, loads, stresses, edge or end conditions other than those allowed under the field of direct application in the relevant test method is not covered by this report.

Because of the nature of fire resistance testing and the consequent difficulty in quantifying the uncertainty of measurement of fire resistance, it is not possible to provide a stated degree of accuracy of the result.

11. FIELD OF DIRECT APPLICATION OF TESTED RESULTS (točka 13)

The results of fire test are directly applicable to similar constructions where one or more of the changes listed below are made and the construction continues to comply with the appropriate design code for its stiffness and stability.

- a) Decrease in height
- b) Increase in the thickness of the wall
- c) Increase in the thickness of component materials
- d) Decrease in linear dimensions of boards or panels but not thickness
- e) Decrease in stud spacing
- f) Decrease in distance of fixing centres
- g) Increase in the number of horizontal joints, of the type tested, when tested with one joint not more than 500 mm from the top edge
- h) The use of surface fittings and fixtures when tested as illustrated in figure 10 of standard SIST EN 1364-1:1999 with the fixture of fitting not more than 500 mm from top edge
- i) Increase in the number of vertical joints, of the type tested, when tested with one joint not more than 500 mm from the top edge

The width of an identical construction may be increased because the specimen was tested at minimum of nominally 3 m wide with one vertical edge without restraint.

The height of construction tested at a minimum of 3 m, may be increased to 4 m because the following conditions:

- a) the maximum lateral deflection of the test specimen was not in excess of 100 mm
- b) the expansion allowance must be increased pro-rata

The result of a test of a non-loadbearing wall tested in one of the standard supporting constructions given in SIST EN 1363-1, or the test frame, is applicable to other supporting construction within the same type (rigid, low density or flexible) that has a greater fire resistance (thicker, denser, more layers of boards, as appropriate).

12. ENCLOSURES:

- 1 sketch of the temperature rise and deflection measurement points
- 2 diagram and table of furnace temperature rise (2 pages)
- 3 diagram of overpressure in the furnace
- 4 diagrams and tables of temperature rise on the unexposed face (6 pages)
- 5 ambient temperature
- 6 drawings provided by the sponsor (3 pages)
- 7 12 photographs (6 pages):
 - 26932d-02 mounting of the specimen before the test
 - 26932d-06 the gap between two frames
 - 26924d-01 exposed side of the specimen before the test
 - 26924d-02 exposed side of the specimen before the test
 - 20624d-03 exposed side of the specimen before the test
 - 20624d-05 beginning of the test
 - 20624d-07 31th minute of testing time
 - 20624d-09 62nd minute of testing time
 - 20624d-12 90th minute of testing time
 - 20624d-20 110th minute of testing time – thermocouple on measuring point 9 fell off, because it was attached on a screw
 - 20624d-25 120th minute of testing time
 - 20624d-27 120th minute of testing time

The report was prepared by: Metod Gaber B.Sc.



TEMPERATURE AND DEFLECTION MEASUREMENT POINTS

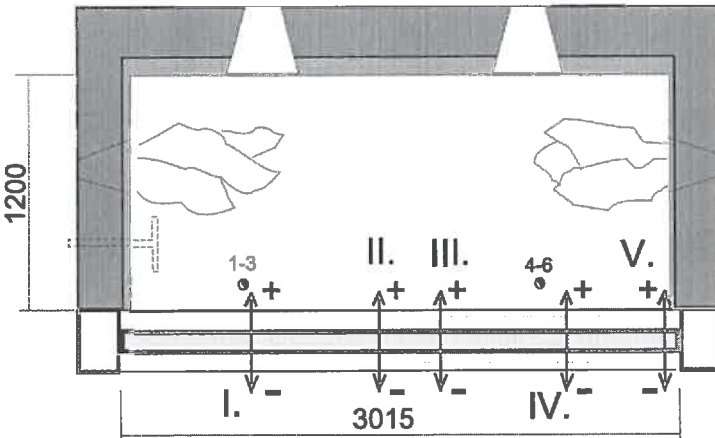
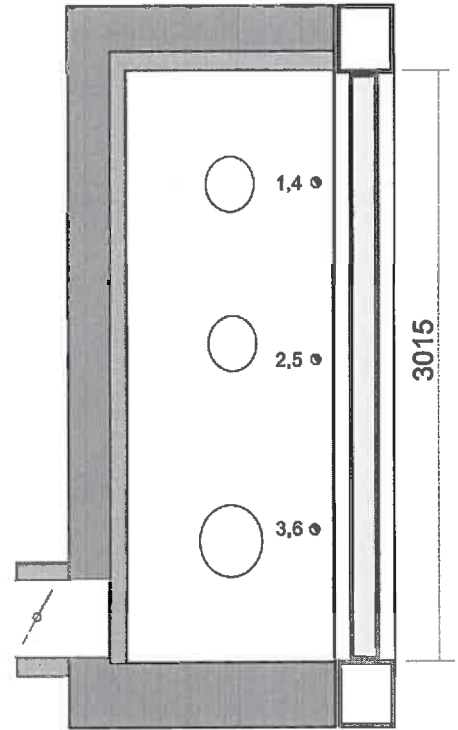
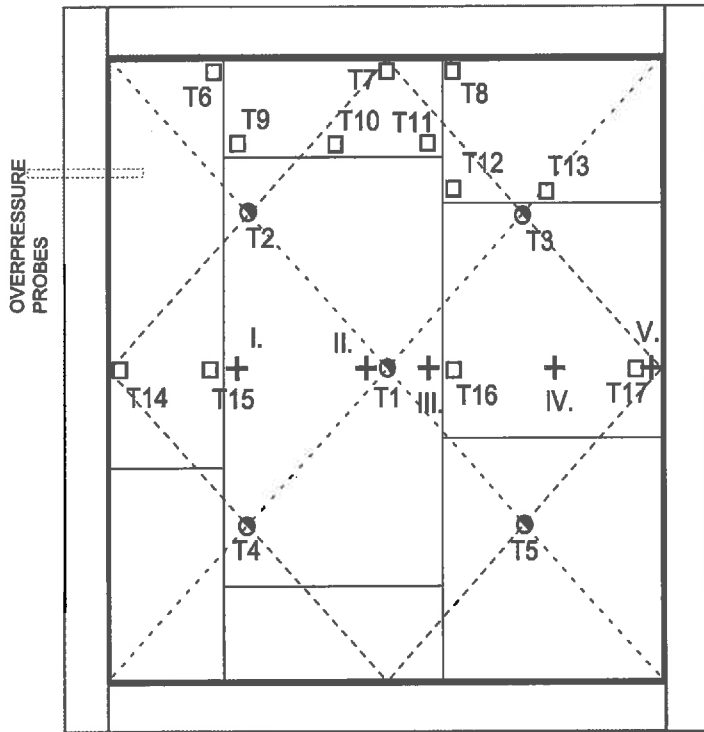

Thermocouples NiCr-Ni

1-6... in the furnace

1-17... on the unexposed face

I-V... deflection measuring points



FURNACE TEMPERATURE RISE

P13-069 Temperature rise in the furnace

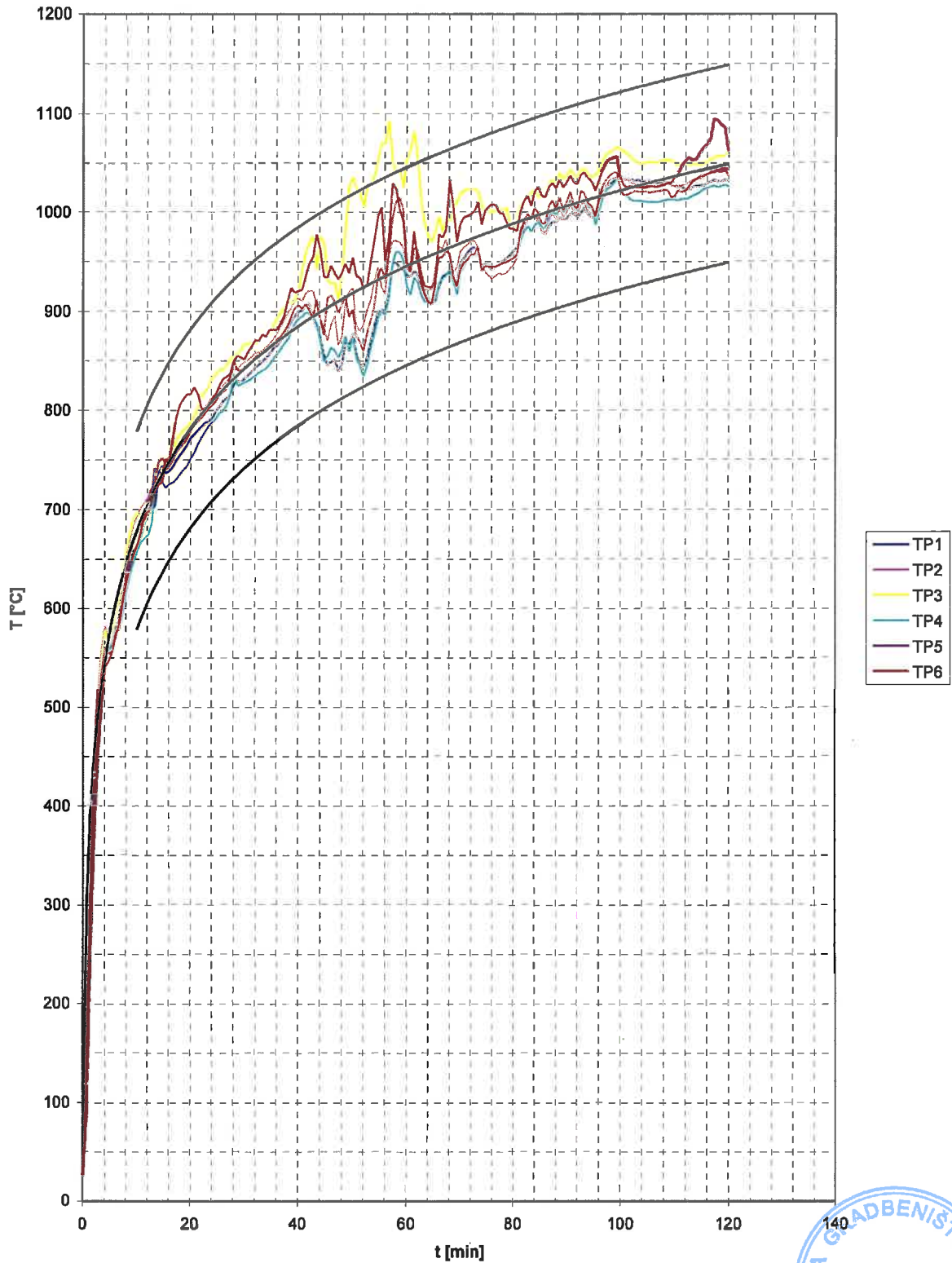

FURNACE TEMPERATURE RISE

Time [min]	Requested furnace temp. [°C]	Average furnace temp. [°C]	Tolerance [%]	Percentage deviation [%]
0	55	26		
4	545	561		2,84
8	646	637	± 15	0,51
12	706	697	± 14	-0,14
16	748	744	± 12	-0,29
20	782	781	± 10	-0,23
24	809	807	± 8	-0,24
28	832	843	± 6	0,02
32	852	854	± 4,8	0,06
36	869	874	± 4,5	0,13
40	885	909	± 4,2	0,43
44	899	911	± 3,8	0,52
48	912	894	± 3,5	0,28
52	924	892	± 3,2	-0,05
56	935	944	± 2,8	0,04
60	945	959	± 2,5	0,15
64	955	926	± 2,5	-0,08
68	964	969	± 2,5	-0,04
72	973	977	± 2,5	-0,01
76	981	962	± 2,5	-0,12
80	988	963	± 2,5	-0,26
84	996	1005	± 2,5	-0,20
88	1003	1006	± 2,5	-0,17
92	1009	1010	± 2,5	-0,16
96	1016	1018	± 2,5	-0,14
100	1022	1035	± 2,5	-0,07
104	1028	1027	± 2,5	-0,07
108	1033	1028	± 2,5	-0,09
112	1039	1031	± 2,5	-0,12
116	1044	1041	± 2,5	-0,12
120	1049	1043	± 2,5	-0,14

The test results relate only to the tested sample. Test report may be reproduced only as a whole.

Obr. P.S. 12-001-01/2



OVERPRESSURE IN THE FURNACE

P13-069 Pressure in the furnace

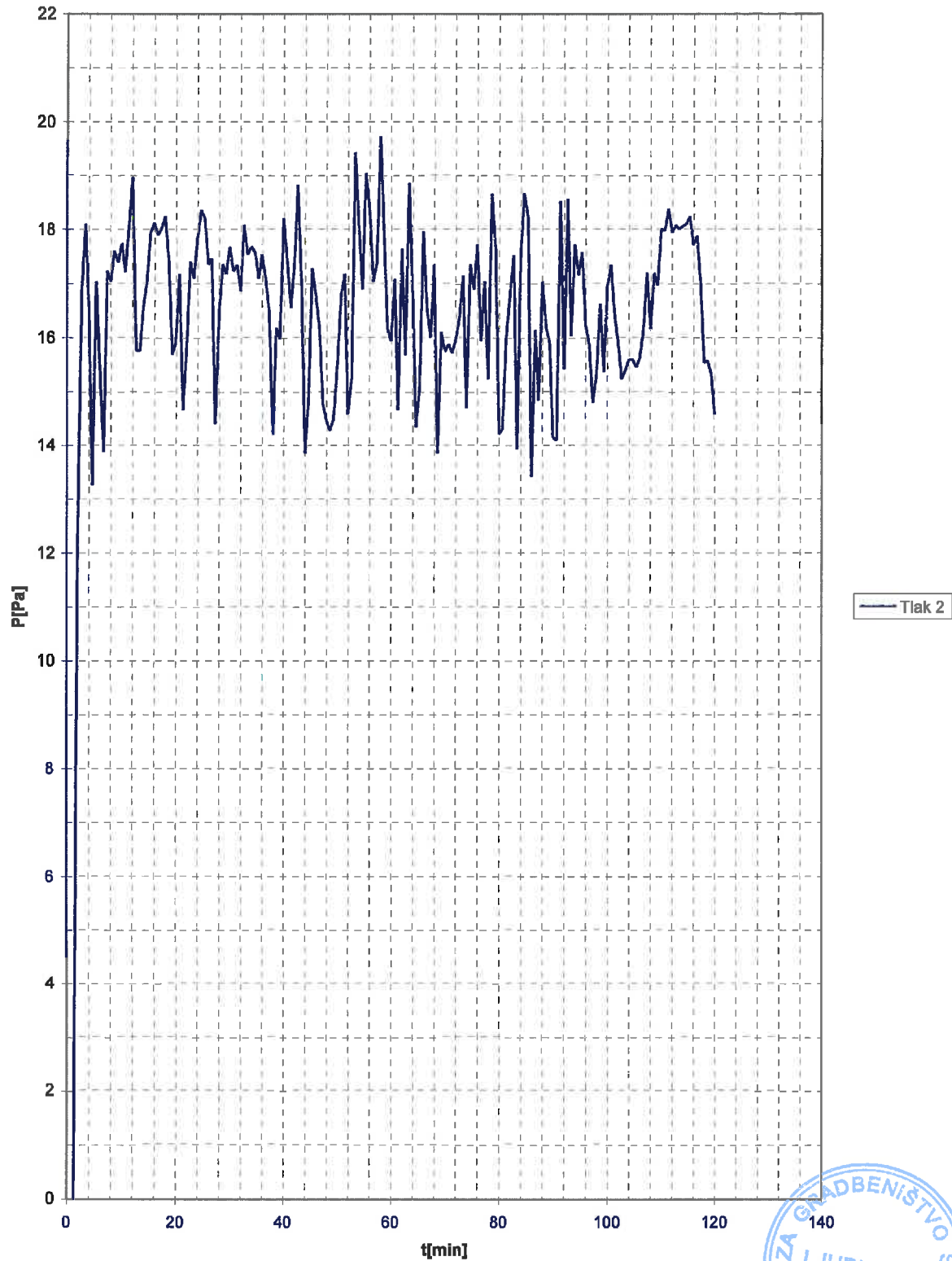

TEMPERATURE RISE ON THE UNEXPOSED FACE

P13-069 Temperature rise on the unexposed face

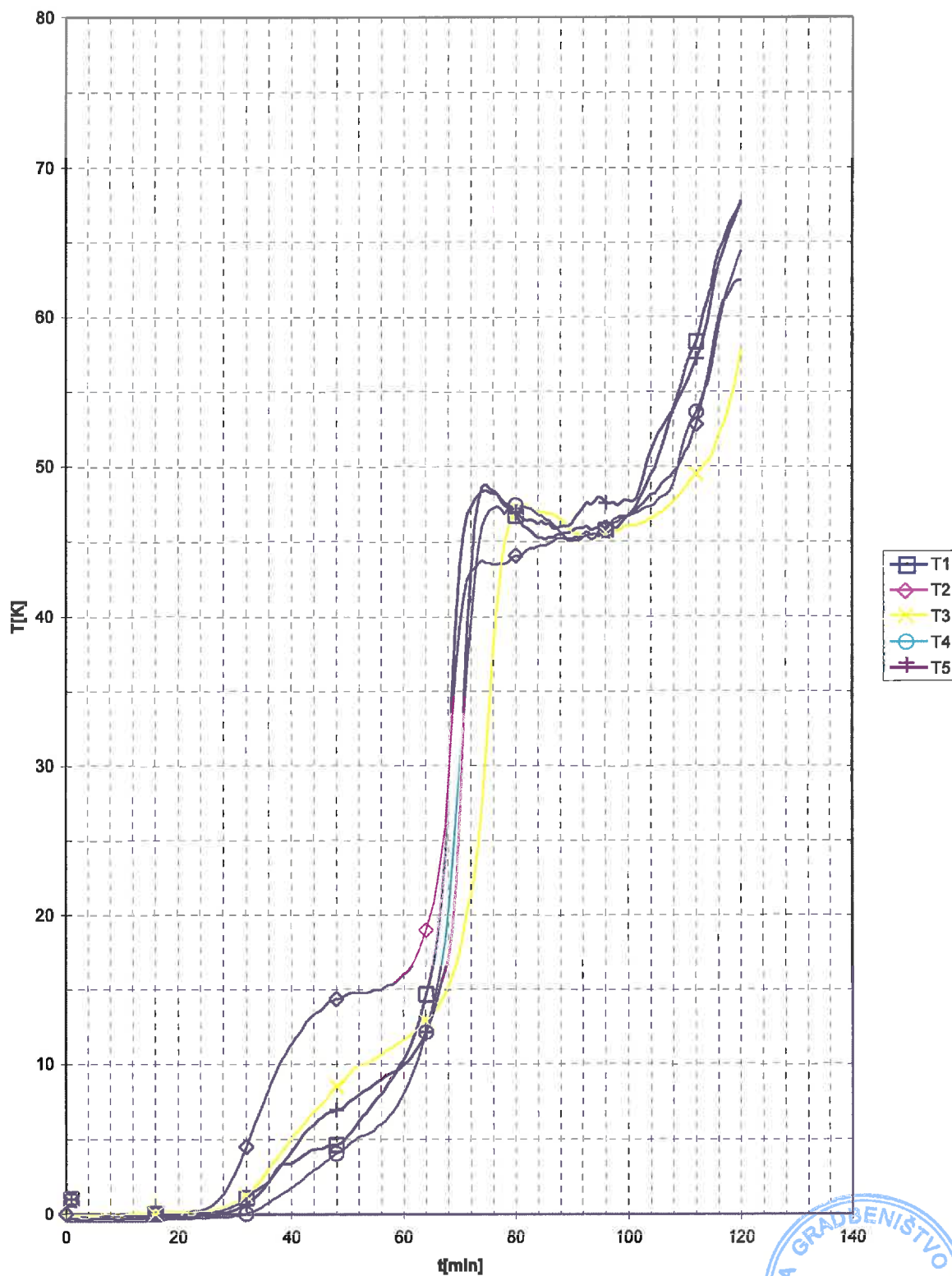

The test results relate only to the tested sample. Test report may be reproduced only as a whole.
Obr. P.S. 12-001-01/2



TEMPERATURE RISE ON THE UNEXPOSED
FACE

P13-069 Temperature rise on the unexposed face

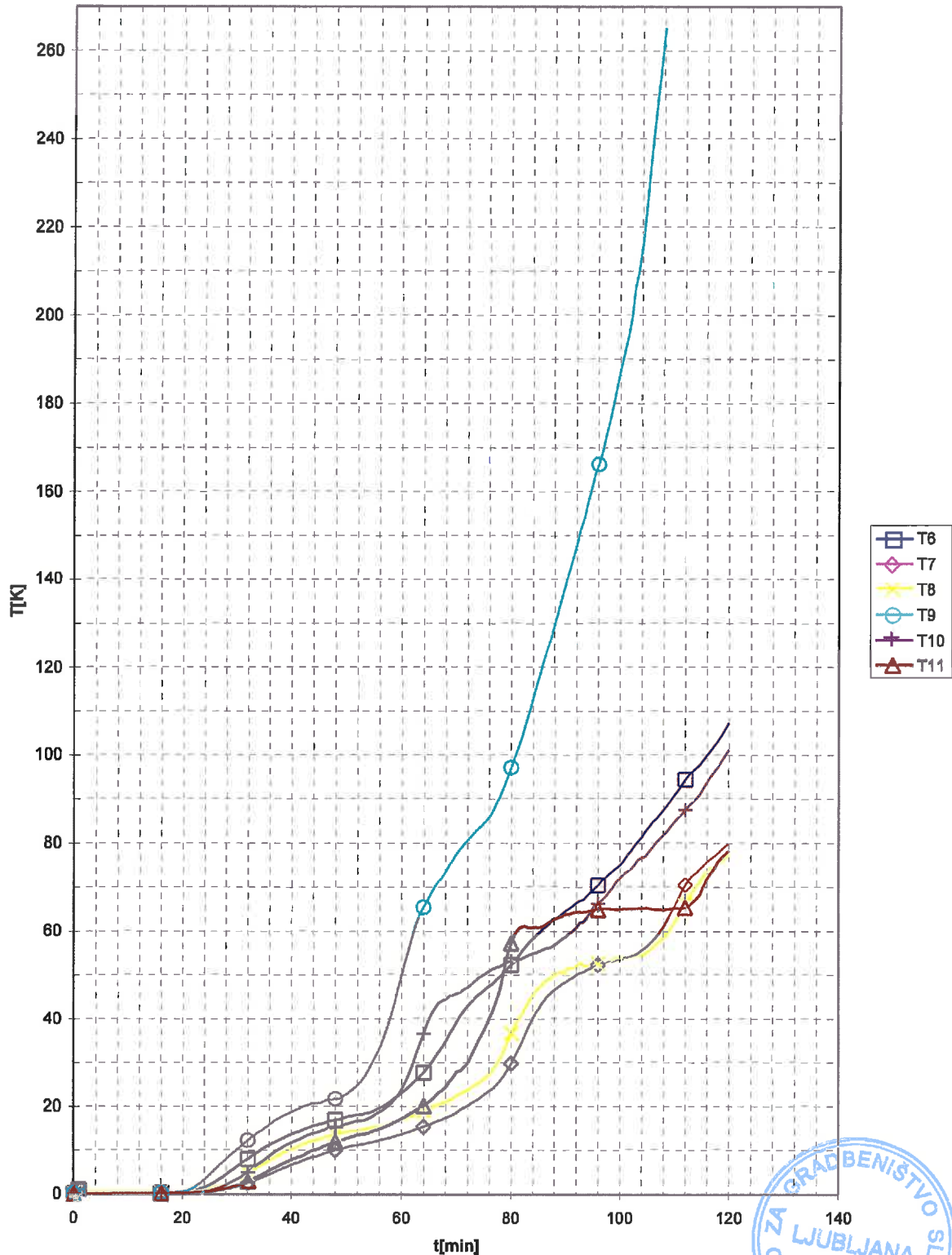

The test results relate only to the tested sample. Test report may be reproduced only as a whole.

Obr. P.S. 12-001-01/2

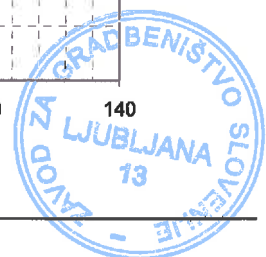

TEMPERATURE RISE ON THE UNEXPOSED FACE

P13-069 Temperature rise on the unexposed face

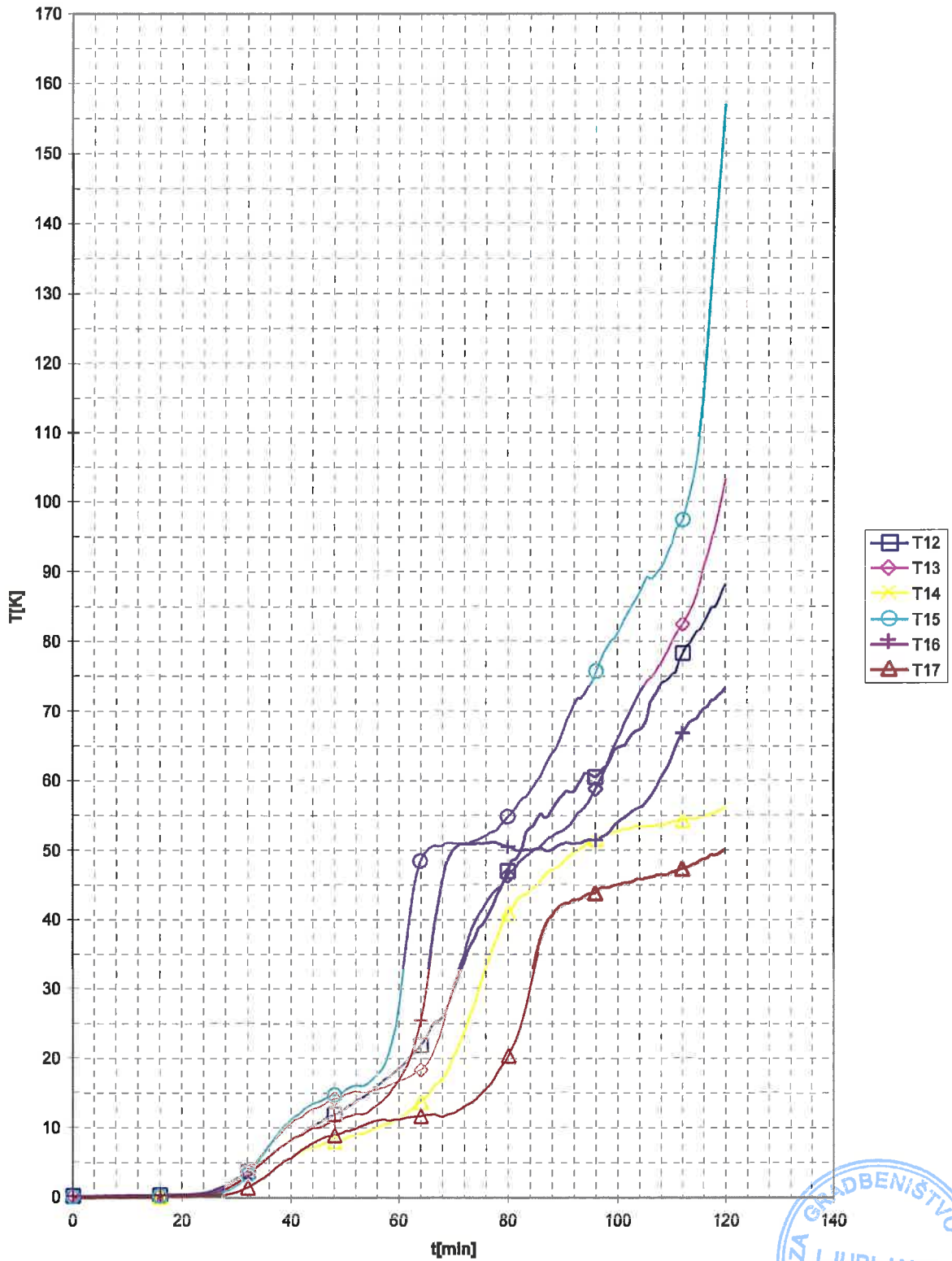

The test results relate only to the tested sample. Test report may be reproduced only as a whole.

Obr. P.S. 12-001-01/2

AVERAGE TEMPERATURE RISE ON THE UNEXPOSED FACE

Time [min]	Temperature on measuring points 1 to 5 [K]					Average temp. [K]
	T1	T2	T3	T4	T5	
0	-0,1	0,0	-0,1	-0,5	-0,4	-0,2
4	-0,1	0,0	-0,1	-0,5	-0,4	-0,2
8	-0,1	0,0	0,0	-0,5	-0,3	-0,2
12	-0,1	0,0	0,0	-0,5	-0,3	-0,2
16	0,0	0,1	0,0	-0,4	-0,2	-0,1
20	0,0	0,1	0,1	-0,3	-0,2	-0,1
24	0,1	0,2	0,2	-0,3	-0,1	0,0
28	0,3	1,3	0,4	-0,2	0,1	0,4
32	1,1	4,5	1,2	0,0	0,7	1,5
36	2,2	8,4	3,0	0,8	2,2	3,3
40	3,4	11,4	5,1	1,8	4,2	5,2
44	4,3	13,4	6,9	3,0	6,0	6,7
48	4,6	14,4	8,5	4,0	7,0	7,7
52	6,2	14,8	9,9	5,2	8,0	8,8
56	8,0	15,0	10,6	6,0	9,0	9,7
60	10,3	16,0	11,6	8,1	10,0	11,2
64	14,7	19,0	12,9	12,1	12,2	14,2
68	29,0	29,5	15,2	20,4	17,3	22,3
72	47,3	43,0	21,3	39,8	43,1	38,9
76	48,2	43,5	38,1	47,2	48,4	45,1
80	46,7	44,1	47,2	47,4	46,9	46,4
84	45,2	44,7	46,9	46,8	46,1	46,0
88	45,5	45,2	46,4	45,6	46,0	45,7
92	45,9	45,5	45,4	45,3	47,3	45,9
96	45,8	45,9	45,6	45,7	47,6	46,1
100	46,8	46,7	46,1	46,7	47,8	46,8
104	49,5	48,2	46,5	47,3	51,1	48,5
108	54,0	49,7	47,7	49,0	53,8	50,8
112	58,3	52,8	49,5	53,6	57,2	54,3
116	64,4	60,0	52,2	59,5	63,6	59,9
120	67,8	62,5	57,8	64,4	67,7	64,0

The test results relate only to the tested sample. Test report may be reproduced only as a whole.

Obr. P.S. 12-001-01/2



MAXIMUM TEMPERATURE RISE ON THE UNEXPOSED FACE

Time [min]	Temperature on measuring points 1 to 11 [K]											Maximum temp. [K]
	T1	T2	T3	T4	T5	T6	T7	T8	T9	T10	T11	
0	-0,1	0,0	-0,1	-0,5	-0,4	0,2	0,2	0,4	0,0	0,0	0,0	0,4
4	-0,1	0,0	-0,1	-0,5	-0,4	0,2	0,2	0,4	0,0	0,0	0,0	0,4
8	-0,1	0,0	0,0	-0,5	-0,3	0,2	0,3	0,4	0,0	0,0	0,1	0,4
12	-0,1	0,0	0,0	-0,5	-0,3	0,3	0,3	0,4	0,1	0,1	0,1	0,4
16	0,0	0,1	0,0	-0,4	-0,2	0,3	0,3	0,4	0,2	0,1	0,1	0,4
20	0,0	0,1	0,1	-0,3	-0,2	0,5	0,4	0,6	0,6	0,2	0,2	0,6
24	0,1	0,2	0,2	-0,3	-0,1	1,5	0,6	1,0	3,3	0,5	0,4	3,3
28	0,3	1,3	0,4	-0,2	0,1	4,5	1,2	2,2	8,0	2,1	1,2	8,0
32	1,1	4,5	1,2	0,0	0,7	8,0	2,5	4,6	12,3	5,0	2,9	12,3
36	2,2	8,4	3,0	0,8	2,2	11,2	4,5	7,5	15,9	8,7	5,4	15,9
40	3,4	11,4	5,1	1,8	4,2	13,7	6,6	10,0	18,7	11,7	7,7	18,7
44	4,3	13,4	6,9	3,0	6,0	15,6	8,5	12,0	20,8	13,9	10,0	20,8
48	4,6	14,4	8,5	4,0	7,0	16,9	10,0	13,4	21,7	15,3	11,8	21,7
52	6,2	14,8	9,9	5,2	8,0	18,0	11,2	14,4	24,9	16,7	13,5	24,9
56	8,0	15,0	10,6	6,0	9,0	19,7	12,3	15,4	33,4	18,8	14,9	33,4
60	10,3	16,0	11,6	8,1	10,0	23,2	13,7	16,7	50,2	23,9	17,3	50,2
64	14,7	19,0	12,9	12,1	12,2	27,8	15,4	18,7	65,4	36,7	20,1	65,4
68	29,0	29,5	15,2	20,4	17,3	34,9	17,4	20,8	73,5	44,5	24,4	73,5
72	47,3	43,0	21,3	39,8	43,1	43,0	20,1	23,5	80,6	47,2	29,9	80,6
76	48,2	43,5	38,1	47,2	48,4	47,5	23,6	27,2	85,9	51,0	40,2	85,9
80	46,7	44,1	47,2	47,4	46,9	52,4	29,9	36,5	97,2	53,2	57,3	97,2
84	45,2	44,7	46,9	46,8	46,1	58,2	40,2	45,2	112,8	54,9	60,8	112,8
88	45,5	45,2	46,4	45,6	46,0	62,7	46,6	50,0	130,0	56,9	62,7	130,0
92	45,9	45,5	45,4	45,3	47,3	66,4	50,0	52,0	148,2	60,9	64,3	148,2
96	45,8	45,9	45,6	45,7	47,6	70,4	52,4	52,5	166,3	66,3	65,0	166,3
100	46,8	46,7	46,1	46,7	47,8	75,0	53,7	53,8	188,0	72,0	64,9	188,0
104	49,5	48,2	46,5	47,3	51,1	81,3	55,7	54,4	213,1	76,7	65,2	213,1
108	54,0	49,7	47,7	49,0	53,8	87,5	61,1	58,4	245,7	81,9	64,8	245,7
112	58,3	52,8	49,5	53,6	57,2	94,4	70,6	66,0		87,5	65,4	94,4
116	64,4	60,0	52,2	59,5	63,6	100,0	75,7	73,6		93,9	72,0	100,0
120	67,8	62,5	57,8	64,4	67,7	107,4	79,9	77,2		101,2	78,3	107,4



The test results relate only to the tested sample. Test report may be reproduced only as a whole.

MAXIMUM TEMPERATURE RISE ON THE UNEXPOSED FACE

Time [min]	Temperature on measuring points 12 to 17 [K]						Max. temp. [K]
	T12	T13	T14	T15	T16	T17	
0	0,1	0,1	-0,1	0,0	0,1	-0,1	0,1
4	0,1	0,1	-0,1	0,0	0,1	-0,2	0,1
8	0,1	0,2	-0,1	0,1	0,1	-0,1	0,2
12	0,1	0,2	0,0	0,1	0,2	-0,1	0,2
16	0,2	0,2	0,0	0,1	0,2	-0,1	0,2
20	0,3	0,3	0,1	0,2	0,3	0,0	0,3
24	0,6	0,5	0,2	0,3	0,4	0,1	0,6
28	1,7	1,5	0,4	0,8	1,2	0,4	1,7
32	3,6	3,7	1,5	3,1	3,2	1,5	3,7
36	5,9	7,5	3,6	7,4	5,9	3,5	7,5
40	8,1	10,6	5,7	11,1	8,3	5,6	11,1
44	10,2	12,7	7,0	13,3	9,9	7,8	13,3
48	11,9	14,2	7,9	14,6	11,0	8,9	14,6
52	13,8	15,2	8,9	16,0	12,0	9,9	16,0
56	16,0	15,5	10,0	17,6	13,3	11,0	17,6
60	18,6	16,7	11,4	27,9	17,0	11,2	27,9
64	21,8	18,3	13,6	48,4	25,4	11,7	48,4
68	25,9	24,6	16,9	50,6	45,5	11,6	50,6
72	33,8	34,8	23,7	50,8	50,9	13,1	50,9
76	40,0	42,3	33,2	52,1	51,1	15,6	52,1
80	47,0	46,3	40,7	54,8	50,6	20,4	54,8
84	53,2	49,5	44,2	58,4	50,0	30,3	58,4
88	55,8	51,9	47,1	63,9	50,1	40,4	63,9
92	58,4	54,4	49,6	70,9	50,9	42,8	70,9
96	60,5	58,8	51,5	75,6	51,5	43,8	75,6
100	64,7	66,0	52,6	81,2	54,0	45,0	81,2
104	67,3	72,5	53,4	87,0	56,2	45,9	87,0
108	74,0	76,9	53,5	90,5	60,4	46,4	90,5
112	78,2	82,4	54,2	97,4	66,8	47,3	97,4
116	82,7	90,9	54,8	114,6	70,3	48,6	114,6
120	88,2	103,4	56,1	157,2	73,3	50,0	157,2



The test results relate only to the tested sample. Test report may be reproduced only as a whole.

Obr. P.S. 12-001-01/2

AMBIENT TEMPERATURE

P13-069 Ambient temperature

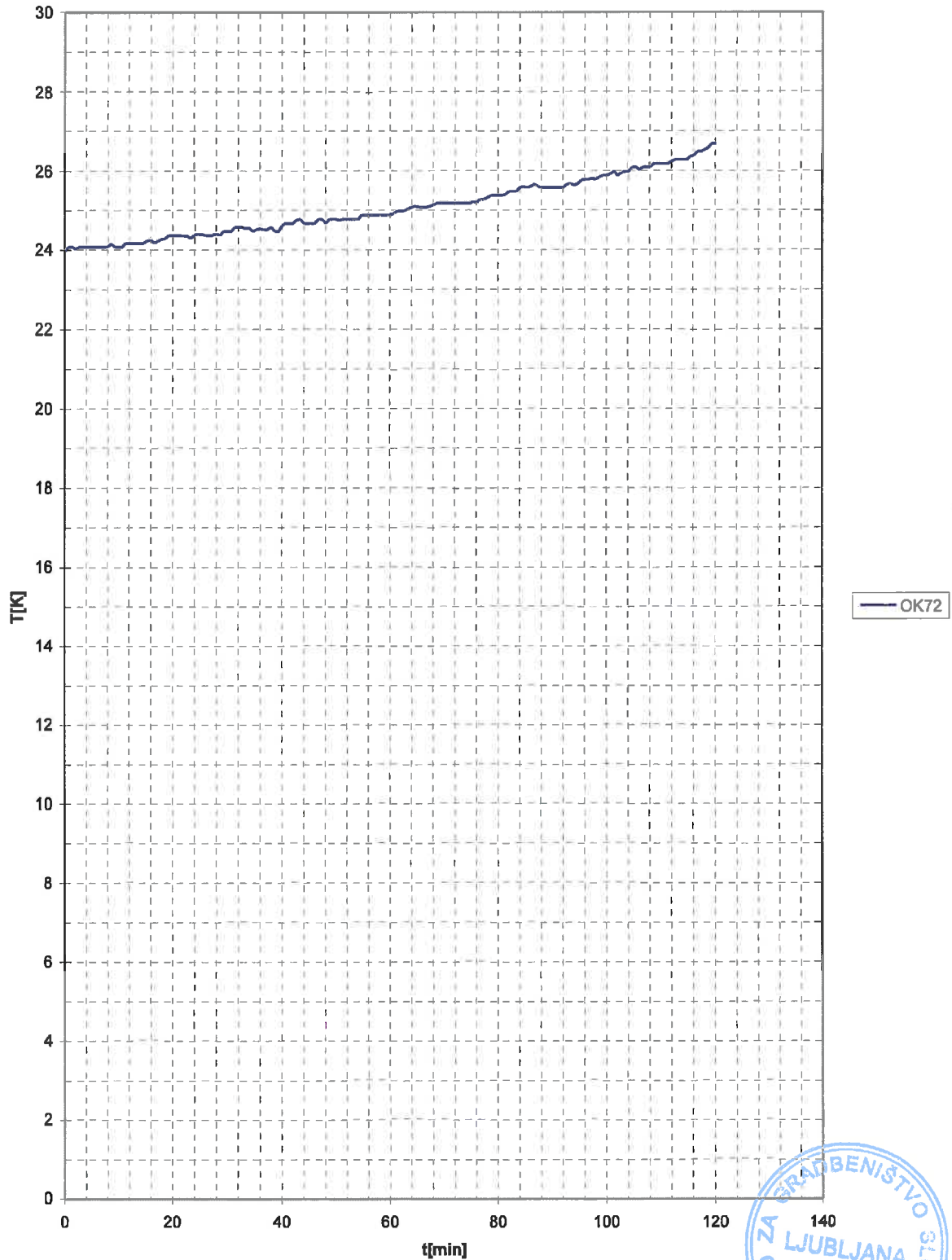

WALL SECTION

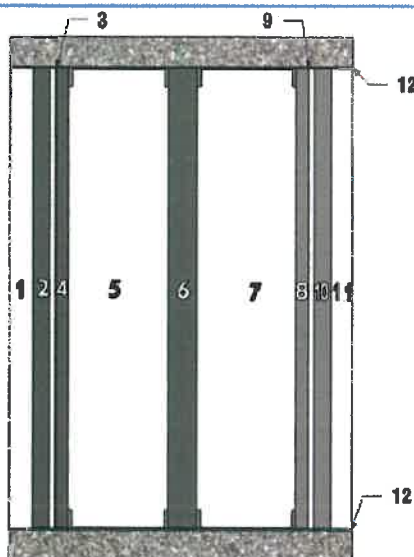
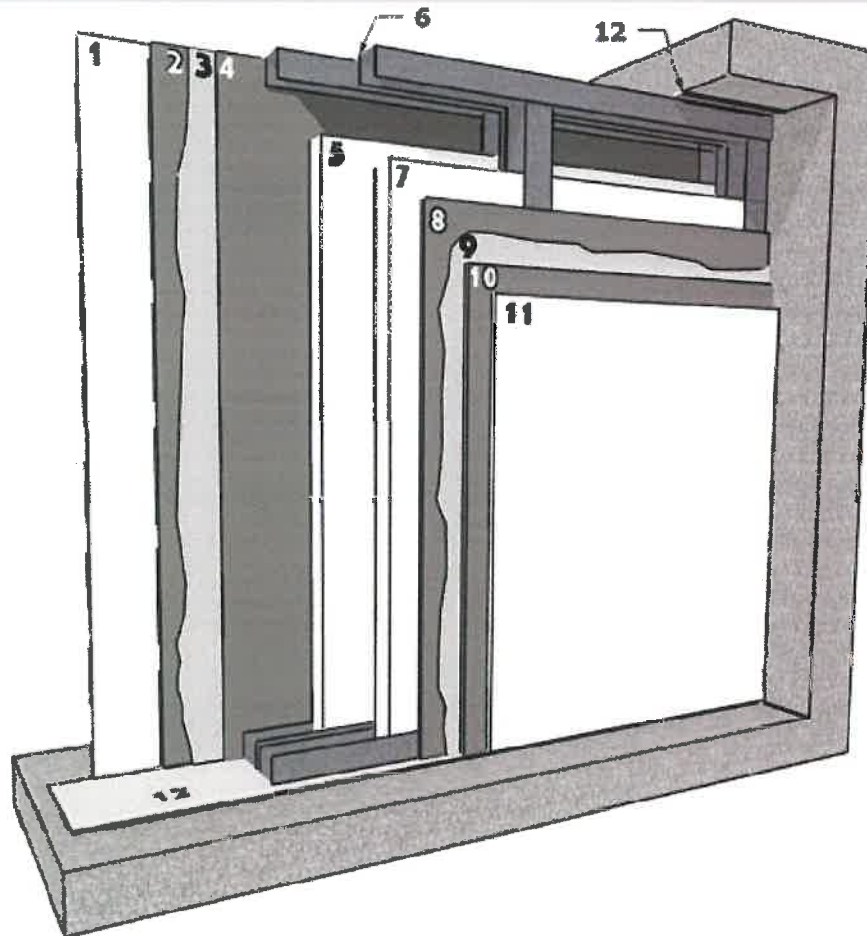

WALL SECTION

1. Knauf Plaster Board GKB (A) 12.5 mm
2. Knauf Plaster Board GKB (A) 12.5 mm
3. Water-based glue Fonocoll
4. Index Topsilent Bitex sound barrier 3 mm (4 kg/m²)
5. Knauf DP-5 mineral wool insulation (50 kg/m³)
6. Air gap 30 mm
7. Knauf DP-5 mineral wool insulation (50 kg/m³)
8. Index Topsilent Bitex sound barrier 3 mm (4 kg/m²)
9. Water-based glue Fonocoll
10. Knauf Plaster Board GKB (A) 12.5 mm
11. Knauf Plaster Board GKB (A) 12.5 mm
12. Uncoupling Index PE-strip FONOCCELL

The test results relate only to the tested sample. Test report may be reproduced only as a whole.

Obr. P.S. 12-001-01/2





List of products/material used to built the acoustic wall specimen tested at ZAG Ljubljana laboratory against fire:

- Knauf Plasterboard GKB (A) 12,5 mm
- **Index TOPSILENT BITEX sound barrier 3 mm (4 kg/m²)**
- Knauf metal profile C-50
- Knauf metal profile U-50
- Knauf Insulation DP-5 (mineral wool 50 kg/m³)
- **Index FONOCCELL uncoupling PE-strip**
- **Index FONOCOLL water-based glue for coupling Topsilent Bitex on Plasterboard**
- **Index NASTROGIPS tape and STUCCOJOINT filler for sealing and finishing off-lined Plasterboard panel joints**
- Knauf fixing screws TN 3,5 x 25 mm and TN 3,5 x 35 mm

PLASTERBOARD WALL ON DOUBLE METAL FRAMEWORK construction

The perimeter of the metal framework will be uncoupled from the building structure with **Index FONOCCELL PE-strip**

Each wall face will be enclosed by a double layer of slabs in covered plaster screwed on vertical metal uprights at distances of 60 cm, with an inserted dampening layer consisting of (from inside to outside):

- a self-bearing Knauf Insulation DP-5 panels made of mineral wool having a thermal conductivity of $\lambda=0,035$ W/mK and a density of 50 Kg/m³ filling the delimited 50 mm interspace of the metal frame.
- A high density soundproof foil with mass per unit area of 4 Kg/m², based on a compound having a critical frequency higher than 85.000 Hz, type **Topsilent Bitex**, which will be glued to the plasterboard using **Fonocoll**. A **Nastrogips** joint-covering mesh will be laid across the slab joining lines for the purpose of reinforcing the joint seals, to be effected with **Stuccojoint** stucco.

A 20 mm air gap will separate the two metal frame works.

The Index wall specimen, tested at ZAG in Ljubljana, was built in accordance to the a.m. materials and building instructions, fitting the size of the ZAG metal frame bearing the plasterboard wall on double metal framework as per your enclosed sketch:



index

Construction Systems and Products

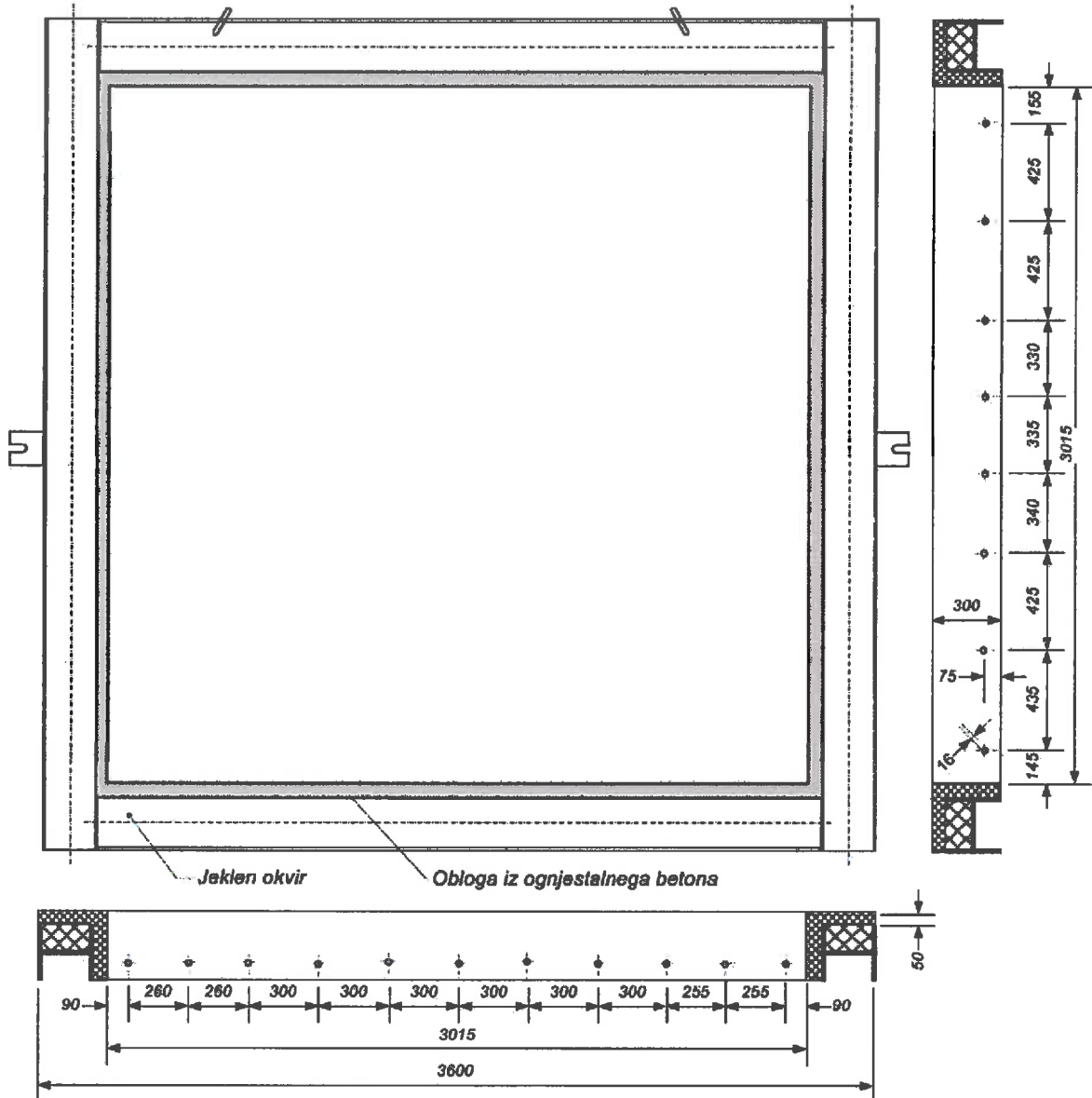

The test results relate only to the tested sample. Test report may be reproduced only as a whole.

Obr. P.S. 12-001-01/2





Photo No. 26932d-02: Mounting of the specimen before the test



Photo No. 26932d-06: Gap between frameworks

The test results relate only to the tested sample. Test report may be reproduced only as a whole.

Obr. P.S. 12-001-01/2





Photo No. 26924d-01: Exposed side of the specimen before the test



Photo No. 26924d-02: Exposed side of the specimen before the test





Photo No. 26924d-03: Exposed side of the specimen before the test

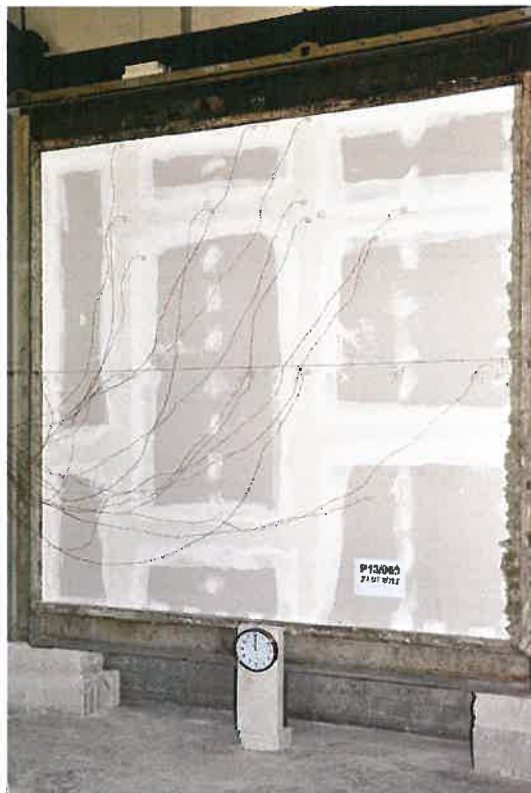

Photo No. 26924d-05: Beginning of the test



Photo No. 26924d-07: 31st minute of testing time



Photo No. 26924d-09: 62nd minute of testing time

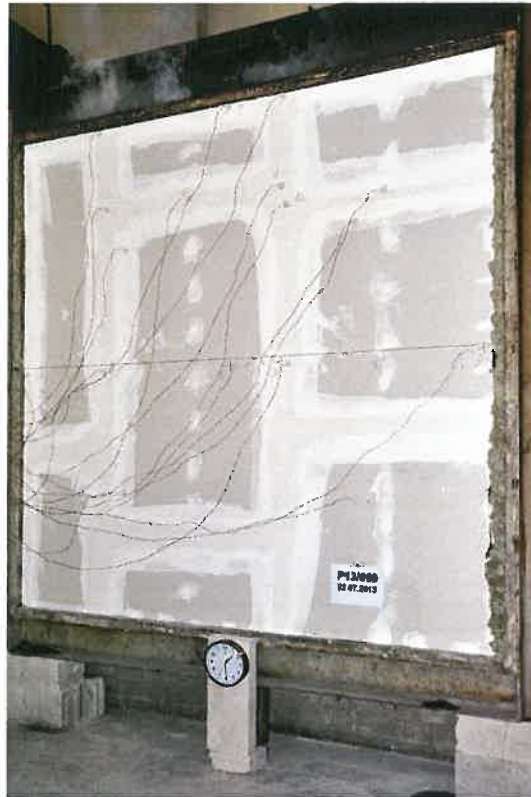

Photo No. 26924d-12: 90th minute of testing time

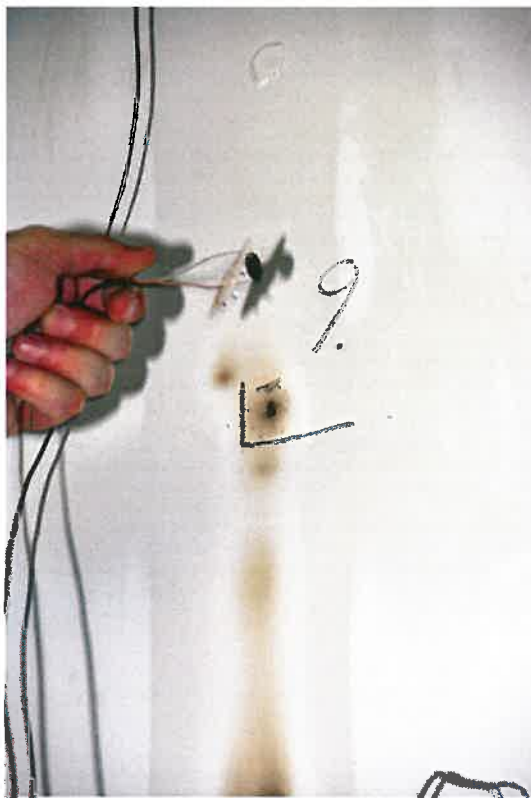

Photo No. 26924d-20: 110th minute of testing time – Thermocouple on measuring point 9 fell off, because it was attached on a screw

The test results relate only to the tested sample. Test report may be reproduced only as a whole.

Obr. P.S. 12-001-01/2

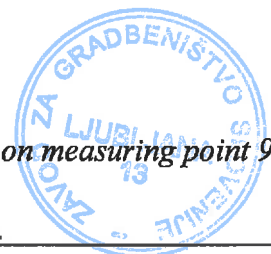



Photo No. 26924d-25: 120th minute of testing time



Photo No. 26924d-27: 120th minute of testing time

